



**PIUSI**

*Fluid Handling  
Innovation*

# K400 ELECTRONIC METER



**MADE  
IN  
ITALY**

Use, maintenance and calibration manual

EN

**BULLETIN MO253E EN 00**



# ENGLISH

# RU

## INDEX

1	FACSIMILE COPY OF EU DECLARATION OF CONFORMITY	3
2	GENERAL WARNINGS	3
3	SAFETY INSTRUCTIONS	4
	3.1 SAFETY WARNINGS	4
	3.2 FIRST AID RULES	4
	3.3 GENERAL SAFETY RULES	5
	3.4 PACKAGING	5
	3.5 PACKAGE CONTENTS/PRE-INSPECTION	5
4	KNOWLEDGE K400	6
	4.1 LCD DISPLAY (ONLY METER VERSION)	6
	4.2 USERS BUTTONS	7
5	INSTALLATION	8
6	DAILY USE	8
	6.1 DISPENSING IN NORMAL MODE	9
	6.1.1 PARTIAL RESET (NORMAL MODE)	9
	6.1.2 RESETTING THE RESET TOTAL	9
7	CALIBRATION	10
	7.1 DEFINITIONS	10
	7.2 CALIBRATION MODE	10
	7.2.1 DISPLAY OF CURRENT CALIBRATION FACTOR AND RESTORING FACTORY FACTOR.	11
	7.2.2 IN FIELD CALIBRATION	11
	7.2.2.1 IN-FIELD CALIBRATION PROCEDURE	12
	7.2.3 DIRECT MODIFICATION OF K FACTOR	13
8	METER CONFIGURATION	14
9	MAINTENANCE	15
	9.1 CHANGE BATTERY	15
	9.2 CLEANING	16
10	MALFUNCTIONS	16
11	DEMOLITION AND DISPOSAL	17
12	TECHNICAL DATA	17
13	EXPLODED VIEWS / MAGNET POSITION	18

## BULLETIN MO253F

translated from italian

**PIUSI K400**

## 1 FACSIMILE COPY OF EU DECLARATION OF CONFORMITY

The undersigned: PIUSI S.p.A.

Via Pacinotti 16/A z.i. Rangavino - 46029 Suzzara - Mantova - Italy

HEREBY STATES under its own responsibility that the equipment described below:

Description : **METER**

Model: **K400**

Serial number: refer to Lot Number shown on CE plate affixed to product

Year of manufacture: refer to the year of production shown on the CE plate affixed to the product

complies with the following legislation:

- Electromagnetic compatibility

The technical file is at the disposal of the competent authority following motivated request at PIUSI S.p.A.

or following request sent to the e-mail address: [doc\\_tec@piusi.com](mailto:doc_tec@piusi.com).

THE ORIGINAL DECLARATION OF CONFORMITY IS PROVIDED SEPARATELY WITH THE PRODUCT

## 2 GENERAL WARNINGS

### Warnings

To ensure operator safety and to protect the dispensing system from potential damage, workers must be fully acquainted with this instruction manual before attempting to operate the dispensing system.

### Symbols used in the manual

The following symbols will be used throughout the manual to highlight safety information and precautions of particular importance:



#### ATTENTION

**This symbol indicates safe working practices for operators and/or potentially exposed persons.**



#### WARNING

**This symbol indicates that there is risk of damage to the equipment and/or its components.**



#### NOTE

**This symbol indicates useful information.**

### Manual preservation

This manual should be complete and legible throughout. It should remain available to end users and specialist installation and maintenance technicians for consultation at any time.

### Reproduction rights

All reproduction rights are reserved by Piusi S.p.A. The text cannot be reprinted without the written permission of Piusi S.p.A.

© Piusi S.p.A.

THIS MANUAL IS THE PROPERTY OF Piusi S.p.A.

ANY REPRODUCTION, EVEN PARTIAL, IS FORBIDDEN.

This manual belongs to Piusi S.p.A., which is the sole proprietor of all rights indicated by applicable laws, including, by way of example, laws on copyrights. All the rights deriving from such laws are reserved to Piusi S.p.A.: the reproduction, including partial, of this manual, its publication, change, transcription and notification to the public, transmission, including using remote communication media, placing at disposal of the public, distribution, marketing in any form, translation and/or processing, loan and any other activity reserved by the law to Piusi S.p.A..

**ZE**

## 3 SAFETY INSTRUCTIONS

### 3.1 SAFETY WARNINGS

**Mains - preliminary checks before installation**



**ATTENTION**

**You must avoid any contact between the electrical power supply and the fluid that needs to be FILTERED.**

**Maintenance control**

Before any checks or maintenance work are carried out, disconnect the power source.

**FIRE AND**



**To help prevent fire and explosion:**

**EXPLOSION**

Use equipment only in well ventilated area.

When flammable fluids are present in the work area, such as gasoline and windshield wiper fluid, be aware that flammable fumes can ignite or explode.



Keep work area free of debris, including rags and spilled or open containers of solvent and gasoline.

Do not plug or unplug power cords or turn lights on or off when flammable fumes are present.

Ground all equipment in the work area.

Stop operation immediately if static sparking occurs or if you feel a shock. Do not use equipment until you identify and correct the problem.

Keep a working fire extinguisher in the work area.

**EQUIPMENT MISUSE**



Misuse can cause death or serious injury

Do not operate the unit when fatigued or under the influence of drugs or alcohol.

Do not leave the work area while equipment is energized or under pressure.

Turn off all equipment when equipment is not in use.

Do not alter or modify equipment. Alterations or modifications may void agency approvals and create safety hazards.

Route hoses and cables away from traffic areas, sharp edges, moving parts, and hot surfaces.

Keep children and animals away from work area.

Comply with all applicable safety regulations.

**TOXIC FLUID OR FUMES HAZARD**



Read MSDSs to know the specific hazards of the fluids you are using.

Store hazardous fluid in approved containers, and dispose of it according to applicable guidelines.

Prolonged contact with the treated product may cause skin irritation: always wear protective gloves during dispensing.

### 3.2 FIRST AID RULES

**Persons who have suffered electric shock**

Disconnect the power source, or use a dry insulator to protect yourself while you move the injured person away from any electrical conductor. Avoid touching the injured person with your bare hands until he is far away from any conductor. Immediately call for help from qualified and trained personnel. Do not operate switches with wet hands.

**SMOKING PROHIBITED**



When operating the system and in particular during refuelling, do not smoke and do not use open flame.

translated from italian

**PIUSI K400**

2

### 3.3 GENERAL SAFETY RULES

#### Essential protective equipment characteristics

Wear protective equipment that is: suited to the operations that need to be performed; resistant to cleaning products.

#### Personal protective equipment that must be worn



Wear the following personal protective equipment during handling and installation:  
Safety shoes;



Close-fitting clothing;



Protective gloves;



Safety goggles;

#### Protective equipment



Instruction manual

### 3.4 PACKAGING

#### FOREWORD

K400 comes packed in a cardboard box with a label indicating the following data:

- 1- contents of the package
- 2- weight of the contents
- 3- description of the product

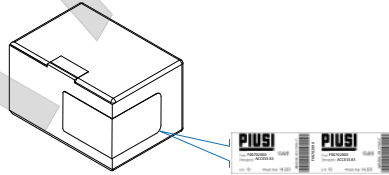

### 3.5 PACKAGE CONTENTS/PRE-INSPECTION

#### FOREWORD

To open the packaging, use a pair of scissors or a cutter, being careful not to damage the dispensing system or its components.

#### NOTE



In the event that one or more of the components described below are missing from inside the package, please contact Piusi inc technical support.

#### WARNING



**Check that the data on the plate correspond to the desired specifications. In the event of any anomaly, contact the supplier immediately, indicating the nature of the defects. Do not use equipment which you suspect might not be safe.**

## 4 KNOWLEDGE K400

### FOREWORD

METER is an electronic digital meter featuring an oval-gear measurement system, designed for easy and precise measuring of oils, diesel, rapsoil and anti-freeze.

### FUNCTIONING PRINCIPLE

The fluid, by flowing through the appliance, rotates the gears which, during their rotation, transfer, "volume units" of fluid. The exact measurement of the dispensed fluid is done by counting the number of rotations made by the gears and consequently the number of transferred "volume units". The magnetic coupling, between the magnets installed in the gears and a magnetic switch outside the measurement chamber, ensures measurement chamber sealing and ensures transmission of the pulses generated by gear rotation to the electronic board microprocessor.

### OPERATIONAL MODE

In the dispensing mode (Normal Mode), the partial and the total amounts are shown in two different registers of the LCD.

The METER features a non-volatile memory for storing the dispensing data, even in the event of a complete power break for long periods.

#### K400 components

- 1- LCD display
- 2- RESET button
- 3- Measurement chamber
- 4- CAL button
- 5- Battery housing

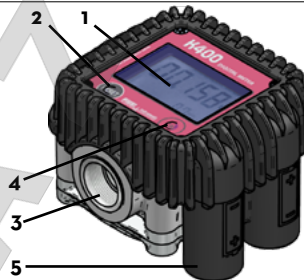

The measurement electronics and the LCD display are fitted in the top part of the meter, isolated from the fluid-bath measurement chamber and sealed from the outside by means of a cover

### 4.1 LCD DISPLAY (ONLY METER VERSION)

#### FOREWORD

The "LCD" of the METER features two numerical registers and various indications displayed to the user only when the applicable function so requires.

1	Partial register (5 figures with moving comma FROM 0.1 to 99999) indicating the volume dispensed since the reset button was last pressed	6	Indication of type of total, (TOTAL / Reset TOTAL);
2	Indication of battery charge	7	Indication of unit of measurement of Totals: L=Litres Gal=Gallons
3	Indication of calibration mode		
4	Totals register (6 figures with moving comma FROM 0.1 to 999999), that can indicate two types of Total: 4.1. General Total that cannot be reset (TOTAL) 4.2. Resettable total (Reset TOTAL)	9	Indication of unit of measurement of Partial: Qts=Quarts Pts=Pints L=Litres Gal=Gallons
5	Indication of total multiplication factor (x10 / x100)		

translated from italian

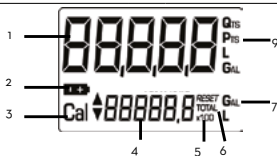
**PIUSI K400**

**Measurement Chamber**

The measurement chamber is located in the lower part of the instrument. It features a threaded inlet and outlet.

The cover on the bottom part provides access to the measurement mechanism for any cleaning operations.

Inside the measurement chamber are the oval gears which, on turning, generate electrical pulses which are processed by the microprocessor-controlled electronic board.

By applying a suitable calibration factor (meaning a "weight" associated with each pulse), the microprocessor translates the pulses generated by the "fluid volume" rotation expressed in the set units of measurement, displayed on the partial and total registers of the LCD. All the meters are factory set with a calibration factor called **FACTORY K FACTOR** equal to 1,000.

For best meter performance - adapting this to the intrinsic characteristics of the fluid to be measured - the instrument can be "calibrated". It is possible to return to factory calibration at any time.

**Battery Housing**

The METER is powered by two standard type 1.5 V batteries (size 1N). The battery housing is closed by a threaded watertight cap that can be easily removed for quick battery change.

**4.2 USERS BUTTONS**
**FOREWORD**

The METER features two buttons (RESET and CAL) which individually perform two main functions and, together, other secondary functions.

**MAIN FUNCTIONS PERFORMED SECONDARY FUNCTIONS LEGEND**

- for the **RESET** key, resetting the partial register and Reset Total
- for the **CAL** key, entering instrument calibration mode

Used together, the two keys permit entering configuration mode where the desired unit of measurement can be set.

**CALIBRATE MEANS PERFORMING ACTIONS ON THE METER KEYS. BELOW IS THE LEGEND OF THE SYMBOLS USED TO DESCRIBE THE ACTIONS TO BE PERFORMED**

<b>Short pressure of cal key</b> 	<b>Long pressure of cal key</b> 	<b>short pressure of reset key</b> 	<b>long pressure of reset key</b> 
--------------------------------------	-------------------------------------	--	---------------------------------------



Installation, use and maintenance

## 5 INSTALLATION

**FOREWORD** The METER features a 1/2 inch inlet and outlet, threaded and perpendicular, and has been designed to be installed in any position, both as fixed in-line installation and as moving installation on a dispensing nozzle.

**ATTENTION**  **Make sure the threaded connections do not interfere with the inside of the measurement chamber causing the gears to seize.**

**METER does not have a fixed direction of flow and both inlets can be used as inlet and outlet**

**Make sure a filter with adequate filtering capacity is always fitted either at meter inlet or at the entrance of the line on which the meter is fitted. If solid particles enter the measurement chamber, the gears could seize.**

**For installations on system, position K400 so that the battery housing can be easily reached.**

**The rubber protection is an integral part of the product. Be sure of its presence and its good conditions**

## 6 DAILY USE

**FOREWORD** The only operations that need to be done for daily use are partial and/or resettable total register resetting. The user should use only the dispensing system of K400. Occasionally the meter may need to be configured or calibrated. To do so, please refer to the relevant chapters.

Below are the two typical normal operation displays. One display page shows the partial and reset total registers. The other shows the partial and general total. Switchover from resettable total to general total display is automatic and tied to phases and times that are in factory set and cannot be changed.

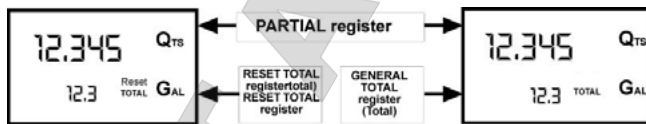

- \* The Partial register positioned in the top part of the display indicates the quantity dispensed since the RESET key was last pressed
  - \* The RESET Total register, positioned in the lower part of the display, indicates the quantity dispensed since the last RESET Total resetting. The RESET Total cannot be reset until the Partial has been reset, while vice versa, the Partial can always be reset without resetting the RESET Total. The unit of measurement of the two Totals can be the same as the Partial or else different according to the factory or user settings.
  - \* The General TOTAL register (Total) can never be reset by the user. It continues to rise for the entire OPERATING life of the meter.
  - \* The register of the two totals (Reset Total and Total) share the same area and digits of the display. For this reason, the two totals will never be visible at the same time, but will always be displayed alternately.
  - \* The General Total (Total) is shown during Meter standby
  - \* The Reset Total is shown:
    - At the end of a Partial reset for a certain time (a few seconds)
    - During the entire dispensing stage
    - For a few seconds after the end of dispensing. Once this short time has expired. Meter switches to standby and lower register display switches to General Total
- 6 digits are available for Totals, plus two icons x 10 / x100. The increment sequence is the following:**  
**0.0 -> 99999.9 -> 999999 -> 100000 x 10 -> 999999 x 10 -> 100000 x 100 -> 999999 x 100**

NOTE







translated from italian

**PIUSI K400**

## 6.1 DISPENSING IN NORMAL MODE

### FOREWORD

Normal mode is the standard dispensing. While the count is made, the partial and resettable total are displayed at the same time (reset total).

### WARNING



Should one of the keys be accidentally pressed during dispensing, this will have no effect.

### STAND BY

A few seconds after dispensing has ended, on the lower register, the display switches from resettable total to general total: the word reset above the word total disappears, and the reset total is replaced by the general total. This situation is called standby and remains stable until the user operates the K400 again.

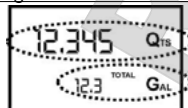
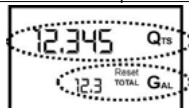

### 6.1.1 PARTIAL RESET (NORMAL MODE)

The partial register can be reset by pressing the reset key when the meter is in standby, meaning when the display screen shows the word "TOTAL".

After pressing the reset key, during reset, the display screen first of all shows all the lit-up digits and then all the digits that are not lit up.

At the end of the process, a display page is first of all shown with the reset partial and the reset total

and, after a few moments, the reset total is replaced by the non resettable Total.

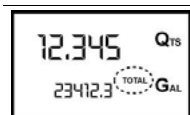

### 6.1.2 RESETTING THE RESET TOTAL

The reset total resetting operation can only be performed after resetting the partial register. The reset total can in fact be reset by pressing the reset key at length while the display screen shows reset total as on the following display page:

Schematically, the steps to be taken are:

- 1 Wait for the display to show normal standby display page (with total only displayed)
- 2 Press the reset key quickly
- 3 The meter starts to reset the partial
- 4 While the display page showing the reset total is displayed





Installation, use and maintenance

Press the reset key again for at least 1 second

- The display screen again shows all the segments of the display followed by all the switched-off segments and finally shows the display page where the reset Reset Total is shown.

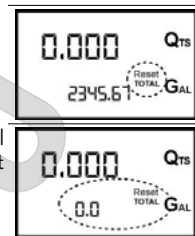

## 7 CALIBRATION

### FOREWORD

METER is supplied with a factory calibration that ensures precise measuring in most operating conditions. Nevertheless, when operating close to extreme conditions, such as for instance:

- with fluids close to acceptable range extremes (such as low-viscosity antifreeze or high-viscosity oils for gearboxes )

In extreme flow rate conditions (close to minimum or maximum acceptable values) on-the-spot calibration may be required to suit the real conditions in which the meter is required to operate.

When operating close to extreme use or flow rate conditions (close to minimum or maximum acceptable values), an on-the-spot calibration may be required to suit the real conditions in which the K400 is required to operate.

### 7.1 DEFINITIONS

#### CALIBRATION FACTOR OR "K FACTOR"

Multiplication factor applied by the system to the electrical pulses received, to transform these into measured fluid units.

#### FACTORY K FACTOR

Factory-set default factor. It is equal to 1,000. This calibration factor ensures utmost precision in the following operating conditions:

**Fluid** motor oil type 10W30

**Temperature:** 20°C

**Flow rate:** 1 - 30 ltr/min

Even after any changes have been made by the user, the factory k factor can be restored by means of a simple procedure.

#### USER

#### K FACTOR:

Customized calibration factor, meaning modified by calibration.

### 7.2 CALIBRATION MODE

#### Why calibrate?

- 1 Display the currently used calibration factor:
- 2 Return to factory calibration (Factory K Factor) after a previous calibration by the user
- 3 Change the calibration factor using one of the two previously indicated procedures

#### FOREWORD

**Two procedures are available for changing the Calibration Factor:**

- 1 In-Field Calibration, performed by means of a dispensing operation
- 2 Direct Calibration, performed by directly changing the calibration factor

In calibration mode, the partial and total dispensed quantities indicated on the display screen take on different meanings according to the calibration procedure phase. In calibration mode, the K400 cannot be used for normal dispensing operations. In "Calibration" mode, the totals are not increased

#### ATTENTION



**The K400 features a non-volatile memory that keeps the data concerning calibration and total dispensed quantity stored for an indefinite time, even in the case of a long power break; after changing the batteries, calibration need not be repeated.**

translated from italian

**PIUSI K400**

## 7.2.1 DISPLAY OF CURRENT CALIBRATION FACTOR AND RESTORING FACTORY FACTOR.



By pressing the CAL key while the appliance is in Standby, the display page appears showing the current calibration factor used. If no calibration has ever been performed, or the factory setting has been restored after previous calibrations, the following display page will appear:

The word "Fact" abbreviation for "factory" shows that the factory calibration factor is being used



If, on the other hand, calibrations have been made by the user, the display page will appear showing the currently used calibration factor (in our example 0,998).

The word "user" indicates a calibration factor set by the user is being used.



**ZE**

The flow chart alongside shows the switchover logic from one display page to another

In this condition, the Reset key permits switching from User factor to Factory factor.

To confirm the choice of calibration factor, quickly press CAL while "User" or "Fact" are displayed.

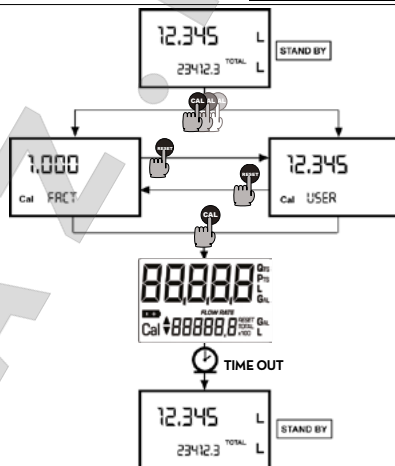
After the restart cycle, the K400 uses the calibration factor that has just been confirmed



### ATTENTION



**When the Factory Factor is confirmed, the old User factor is deleted from the memory**

## 7.2.2 IN FIELD CALIBRATION

### FOREWORD

This procedure calls for the fluid to be dispensed into a graduated sample container in real operating conditions (flow rate, viscosity, etc.) requiring maximum precision.

### ATTENTION



**For correct K400 calibration, it is most important to:**





- 1 When the Factory Factor is confirmed, the old User factor is deleted from the memory
- 2 Use a precise Sample Container with a capacity of not less than 5 litres, featuring an accurate graduated indicator.
- 3 Ensure calibration dispensing is done at a constant flow rate equivalent to that of normal use, until the container is full;
- 4 Not reduce the flow rate to reach the graduated area of the container during the final dispensing stage (the correct method during the final stages of sample container filling consists in making short top-ups at normal operation flow rate);
- 5 After dispensing, wait a few minutes to make sure any air bubbles are eliminated from the sample container; only read the Real value at the end of this stage, during which the level in the container could drop.
- 6 Carefully follow the procedure indicated below.

**7.2.2.1 IN-FIELD CALIBRATION PROCEDURE**

ACTION		DISPLAY
1	<b>NONE</b> Meter in Standby	
2	<b>LONG CAL key keying</b> The Meter enters calibration mode, shows <<CAL>> and displays the calibration factor in use instead of partial. The words "Fact" and "USER" indicate which of the two factors (factory or user) is currently in use. Important: This factor is that which the instrument also uses for field calibration measurement operations	
3	<b>LONG RESET key keying</b> The Meter shows "CAL" and the partial at zero. The Meter is ready to perform in-field calibration.	
4	<b>DISPENSING INTO SAMPLE CONTAINER</b> Without pressing any key, start dispensing into the sample container   Dispensing can be interrupted and started again at will. Continue dispensing until the level of the fluid in the sample container has reached the graduated area. There is no need to reach a preset quantity.  Indicated value      Real value	
5	<b>SHORT RESET key keying</b> The Meter is informed that the calibration dispensing operation is finished. Make sure dispensing is correctly finished before performing this operation. To calibrate the Meter, the value indicated by the partial totaliser (example 9.800) must be forced to the real value marked on the graduated sample container. In the bottom left part of the display an arrow appears (upwards and downwards), that shows the direction (increase or decrease) of the value change displayed when the following operations 6 or 7 are performed.	
6	<b>SHORT RESET key keying</b> The arrow changes direction. The operation can be repeated to alternate the direction of the arrow.	
7	<b>SHORT/LONG CAL key keying</b> The indicated value changes in the direction indicated by the arrow - one unit for every short CAL key keying - continually if the CAL key is kept pressed. The speed increase rises by keeping the key pressed. If the desired value is exceeded, repeat the operations from point (6).	

translated from italian

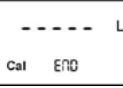
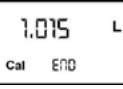
**PIUSI K400**

<p>8</p> 	<p><b>LONG RESET key keying</b></p> <p>The Meter is informed that the calibration procedure is finished.                  Before performing this operation, make sure the INDICATED value is the same as the REAL value.</p> <div style="display: flex; justify-content: space-around; align-items: center;"> <div style="text-align: center;">  <p>Indicated value</p> </div> <div style="text-align: center;">  <p>Real value</p> </div> </div> <p>The Meter calculates the new USER K FACTOR ; this calculation could require a few seconds, depending on the correction to be made</p> <p><b>ATTENTION: If this operation is performed after action (5), without changing the indicated value, the USER K FACTOR would be the same as the FACTORY K FACTOR, thus it is ignored.</b></p>	
<p>9</p>	<p><b>NO OPERATION</b></p> <p>At the end of the calculation, the new USER K FACTOR is shown for a few seconds, after which the restart cycle is repeated to finally achieve standby condition.</p> <p><b>IMPORTANT: From now on, the indicated factor will become the calibration factor used by the Meter and will continue to remain such even after a battery change</b></p>	
<p>10</p>	<p><b>NO OPERATION</b></p> <p>The Meter stores the new work calibration factor and is ready to begin dispensing, using the USER K FACTOR that has just been calculated..</p>	

### 7.2.3 DIRECT MODIFICATION OF K FACTOR

If normal Meter operation shows a mean percentage error, this can be corrected by applying to the currently used calibration factor a correction of the same percentage. In this case, the percentage correction of the USER K FACTOR must be calculated by the operator in the following way

$$\text{New cal. Factor} = \text{Old Cal Factor} * \left( \frac{100 - E\%}{100} \right)$$











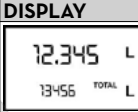

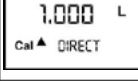

#### EXAMPLE

Error percentage found: E% - 0.9 %

CURRENT calibration factor: 1.000

New USER K FACTOR:  $1.000 * [(100 - (-0.9))/100] = 1.000 * [(100 + 0.9)/100] = 1.009$

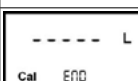
If the Meter indicates less than the real dispensed value (negative error) the new calibration factor must be higher than the old one as shown in the example. The opposite applies if the Meter shows more than the real dispensed value (positive error).

ACTION		DISPLAY
1	<b>NONE</b> METER in Standby.	
2	 <b>LONG CAL KEY KEYING</b> Meter enters calibration mode, shows "CAL" and displays the calibration factor being used instead of the partial. The words "Fact" and "User" indicate which of the two factors (factory or user) is currently being used.	
3	 <b>LONG RESET KEY KEYING</b> The Meter shows "CAL" and the zero partial total. Meter is ready to perform in-field calibration by dispensing – see previous paragraph.	
4	 <b>LONG RESET KEY KEYING</b> We now go on to Direct change of the calibration factor: the word "Direct" appears together with the Currently Used calibration factor. In the bottom left part of the display, an arrow appears (upwards or downwards) defining the direction (increase or decrease) of change of the displayed value when subsequent operations 5 or 6 are performed.	
5	 <b>SHORT RESET KEY KEYING</b> Changes the direction of the arrow. The operation can be repeated to alternate the direction of the arrow.	
6	 <b>SHORT/LONG CAL KEY KEYING</b> The indicated value changes in the direction indicated by the arrow - one unit for every short CAL key keying - continually if the CAL key is kept pressed. The speed increase rises by keeping the key pressed. If the desired value is exceeded, repeat the operations from point (5).	
7	 <b>LONG RESET KEY KEYING</b> The Meter is informed that the calibration procedure is finished. Before performing this operation, make sure the INDICATED value is that required.	
8	<b>NO OPERATION</b> At the end of the calculation, the new USER K FACTOR is shown for a few seconds, after which the restart cycle is repeated to finally achieve standby condition. <b>IMPORTANT: From now on, the indicated factor will become the calibration factor used by the Meter and will continue to remain such even after a battery change</b>	
9	<b>NO OPERATION</b> The Meter stores the new work calibration factor and is ready to begin dispensing, using the USER K FACTOR that has just been changed.	

## 8 METER CONFIGURATION

The METER feature a menu with which the user can select the main measurement unit, Quarts (Qts), Pints (Pts), Litres (Lit), Gallons (Gal);

The combination of the unit of measurement of the Partial register and that of the Totals is pre-defined according to the following table:

Combination no.	Unit of Measurement Partial Register	Unit of Measurement Totals Register
1	Litres (L)	Litres (L)
2	Gallons (Gal)	Gallons (Gal)
3	Quarts (Qts)	Gallons (Gal)
4	Pints (Pts)	Gallons (Gal)

translated from italian

**PIUSI K400**

To choose between the 4 available combinations:

1

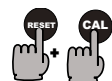

Wait for the METER to go to Standby

Then press the CAL and RESET keys together. Keep these pressed until the word "UNIT" appears on the screen together with the unit of measurement set at that time (in this example Litres / Litres)

2



Every short press of the RESET key, the various combinations of the units of measurements are scrolled as shown below:

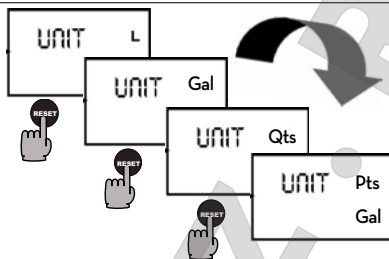

4



**ATTENTION**



By pressing the CAL key at length, the new settings will be stored, the METER will pass through the start cycle and will then be ready to dispense in the set units.

**The Reset Total and Total registers will be automatically changed to the new unit of measurement.**

**NO new calibration is required after changing the Unit of Measurement.**

## 9 MAINTENANCE

### 9.1 CHANGE BATTERY

#### FOREWORD

The METER has been designed to require a minimum amount of maintenance. The only maintenance jobs required are:

- Battery change - necessary when the batteries have run down
- Cleaning the measurement chamber. This may be necessary due to the particular nature of the dispensed fluids or due to the presence of solid particles following bad filtering

#### BATTERY REPLACE- MENT WARNING



Use 2x1.5 V alkaline batteries size AAA

**K400 should be installed in a position allowing the batteries to be replaced without removing it from the system.**

K400 features two low-battery alarm levels:

1



When the battery charge falls below the first level on the LCD, the fixed battery symbol appears. In this condition, K400 continues to operate correctly, but the fixed icon warns the user that it is ADVISABLE to change the batteries.

2



If K400 operation continues without changing the batteries, the second battery alarm level will be reached which will prevent operation. In this condition the battery icon starts to flash and is the only one to remain visible on the LCD.

- To change the batteries, with reference to the exploded diagram positions, proceed as follows
- 1 Press RESET to update all the totals
  - 2 Loosen the 4 fixing screws of the lower cover
  - 3 Remove the old batteries
  - 4 Place the new batteries in the same position of the old ones, being sure that the positive pole is positioned as shown on the rubber protection (pos. 7)
  - 5 Close the cover again, by positioning the rubber protection as a gasket
  - 6 K400 will switch on automatically and normal operation can be resumed

The **METER** will display the same Reset Total, the same Total and the same Partial indicated before the batteries were changed. After changing the batteries, the meter does not need calibrating again.

**ATTENTION**



**Do not discard the old batteries in the environment. Refer to local disposal regulations.**

**9.2 CLEANING**

**FOREWORD**

The METER measurement chamber can be cleaned without removing the instrument from the line or from the dispensing nozzle on which it is fitted.

**ATTENTION**



**Always make sure the liquid has been drained from the meter before cleaning.**

**CLEANING**

To clean the chamber, proceed as follows (with reference to the spare parts list positions)

- 1 Loosen the four cover retention screws (pos. 15)
- 2 Remove the cover (pos. 14) and the seal (pos. 13)
- 3 Remove the oval gears.
- 4 Clean where necessary. For this operation, use a brush or pointed object such as a small screwdriver.
- 5 Be careful not to damage the body or the gears
- 6 To reassemble the instrument, perform the operations in the opposite sequence

**ATTENTION**



**Close the fixing screws on the cover with the tightening couple 8-9-m**  
**Only one of the two gears features magnets. This must be fitted in the position marked "MAGNET" (see drawing). Once the gear has been fitted, the magnets must be visible before closing the cover.**  
**The gears with magnets are to be placed with the magnets on the bottom (see drawing)**

**WARNING**



Fit the second gear (without magnets) with axis greater than 90° compared to the first gear, and with the holes visible from the cover side  
Make sure the gears are turning freely before closing the cover.

**10 MALFUNCTIONS**

PROBLEM	POSSIBLE CAUSE	REMEDIAL ACTION
LCD: NO INDICATION	Bad battery contact Wrong K FACTOR	Check battery contacts With reference to paragraph H, check the K FACTOR
NOT ENOUGH MEASUREMENT PRECISION	The meter works below minimum acceptable flow rate.	Increase the flow rate until an acceptable flow rate range has been achieved
REDUCED OR ZERO FLOW RATE	Gears blocked	Clean the measurement chamber
THE METER DOES NOT COUNT, BUT THE FLOW RATE IS CORRECT	Incorrect installation of gears after cleaning Possible electronic card problems	Repeat the reassembly procedure Contact your dealer



translated from italian

**PIUSI K400**

## 11 DEMOLITION AND DISPOSAL

<b>Foreword</b>	If the system needs to be disposed, the parts which make it up must be delivered to companies that specialize in the recycling and disposal of industrial waste and, in particular:
<b>Disposing of packing materials</b>	The packaging consists of biodegradable cardboard which can be delivered to companies for normal recycling of cellulose.
<b>Metal Parts Disposal</b>	Metal parts, whether paint-finished or in stainless steel, can be consigned to scrap metal collectors.
<b>Disposal of electric and electronic components</b>	These must be disposed of by companies that specialize in the disposal of electronic components, in accordance with the indications of directive 2012/19/EU (see text of directive below). European Directive 2012/19/EU requires that all equipment marked with this symbol on the product and/or packaging not be disposed of together with non-differentiated urban waste. The symbol indicates that this product must not be disposed of together with normal household waste. It is the responsibility of the owner to dispose of these products as well as other electric or electronic equipment by means of the specific refuse collection structures indicated by the government or the local governing authorities.
	
<b>Information regarding the environment for clients residing within the European Union</b>	Disposing of RAEE equipment as household wastes is strictly forbidden. Such wastes must be disposed of separately. Any hazardous substances in the electrical and electronic appliances and/or the misuse of such appliances can have potentially serious consequences for the environment and human health. In case of the unlawful disposal of said wastes, fines will be applicable as defined by the laws in force.
<b>Miscellaneous parts disposal</b>	Other components, such as pipes, rubber gaskets, plastic parts and wires, must be disposed of by companies specialising in the disposal of industrial waste.

## 12 TECHNICAL DATA

<b>Measurement system</b>	Oval gears
<b>Resolution (nominal)</b>	0.005 lit/pulse
<b>Flow Rate (Range)</b>	1 - 30 (Litres/minute)
<b>Operating pressure (Max)</b>	70 (Bar) 145 (psi)
<b>Bursting pressure (Min)</b>	200 (Bar)
<b>Storage temperature (Range)</b>	-20 · + 70 (°C)
<b>Storage humidity (Max)</b>	95 (% RU)
<b>Operating temperature (Range)</b>	-10 · + 50 (°C)
<b>Flow resistance (at 15l/min with oil SAE10W at 20°C)</b>	0.35 bar
<b>Permissible Viscosity (Range)</b>	5 · 5000 mPas
<b>Accuracy (from 1 to 30 l/min)</b>	+/- 0,5% of the value indicated after calibration
<b>Reproducibility (Typical)</b>	+/- 0,3 (%)
<b>Screen</b>	Liquid crystals LCD. Featuring: - 5-figure partial - 6-figure Reset Total plus x10 / x100 - 6-figure non reset Total plus x10 / x100
<b>Power Supply</b>	2x1.5 V alkaline batteries size AAA
<b>Battery life</b>	18 · 36 months
<b>Weight</b>	0.5 Kg (included batteries)
<b>Protection</b>	IP65
<b>BULB (pulsar)</b>	Max current: 100 mA Max Voltage: 28V MaxLoad: 3V



Installation, use and maintenance

## 13 EXPLODED VIEWS / MAGNET POSITION

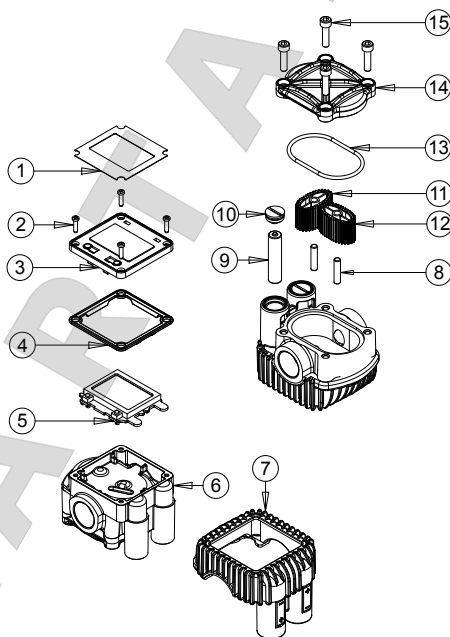
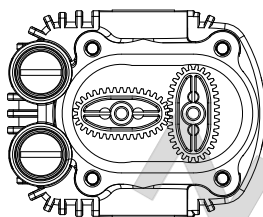
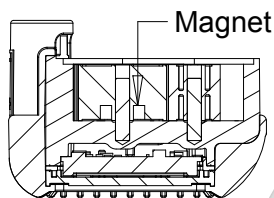



**ARTAZ**  
ГРУППА КОМПАНИЙ

Москва, шоссе Энтузиастов 31с50  
Санкт-Петербург, ул. Заусадбная 31

ООО «АРТАЗ» +7 (958) 762-88-45, <https://artaz.ru>, Почта: [info@artaz.ru](mailto:info@artaz.ru)  
Видеообзоры оборудования: <https://youtube.com/@artazru>

ARTAZ.RU



**ARTAZ**  
ГРУППА КОМПАНИЙ

Москва, шоссе Энтузиастов 31с50  
Санкт-Петербург, ул. Заусадбная 31

ООО «АРТАЗ» +7 (958) 762-88-45, <https://artaz.ru>, Почта: [info@artaz.ru](mailto:info@artaz.ru)  
Видеообзоры оборудования: <https://youtube.com/@artazru>



*Fluid Handling  
Innovation*

IT Scarica il manuale nella tua lingua!  
EN Download the manual in your language!  
CS Stáhnout příručku ve vašem jazyce!  
DA Download manualen på dit sprog!  
DE Laden Sie das Handbuch in Ihrer Sprache herunter!  
ES ¡Descarga el manual en tu idioma!  
FI Lataa käsikirja omalla kielelläsi!  
FR Téléchargez le manuel dans votre langue!  
NL Download de handleiding in uw taal!  
PL Pobierz instrukcję w swoim języku!  
PT Baixe o manual em seu idioma!  
RU Загрузите руководство на вашем языке



[https://www.piusi.com/  
support/search-manuals](https://www.piusi.com/support/search-manuals)

**piusi.com**  
PIUSI SpA • Suzzara MN Italy

**BULLETIN MO253E EN 00**

01 2024

