

OPERATING INSTRUCTIONS AND SAFETY NOTES

Turbine Flow Meter





Operating instructions - turbine flow meter

FMT Swiss AG

This documentation is exclusively intended for the operating company and their staff.

Without our written consent, the content of this documentation (textes, figures, drawings, charts, diagrams etc.), must not be duplicated or distributed, neither in full or in part, utilized for the purpose of competition or passed on/made available to third parties.

FMT Swiss AG

Fluid Management Technologies Swiss AG
Gewerbstraße 6
6330 Cham / Schweiz
Tel. +41 41 712 05 37
Fax +41 41 720 26 21
Email: info@fmtag.com
Internet: www.fmtag.com

Operating instructions translation

Date of issue: 10/2016

We reserve the right to make design and product modifications, which serve to improve the product.





Operating instructions - turbine flow meter

Table of Contents

1.	Introduction	4
1.1.	Preface	4
1.2.	Obligations of the personnel	4
1.3.	Symbols in this manual	4
1.3.1.	Structure of the warning notes	4
1.3.2.	Hazard warning symbols	5
1.3.3.	General symbols	5
2.	Safety notes	5
2.1.	Authorized personnel	6
2.2.	Risks when handling the turbine flow meter	6
3.	Intended conditions of use	6
3.1.	Design and functional description	6
3.1.1.	Display LCD	7
3.1.2.	User controls	8
3.1.3.	Measuring chamber	9
3.1.4.	Battery compartment	9
4.	Technical data	9
5.	Montage	10
6.	Installation	10
7.	Routine operation	10
7.1.	Output of liquid during standard operation (Normal Mode)	11
7.1.1.	Resetting partial volumes	11
7.1.2.	Resetting the resettable total volume (RESET TOTAL)	12
7.2.	Output of liquid with display of current flow rate (Flow Rate Mode)	12
7.2.1.	Resetting partial volumes	13
8.	Calibration	13
8.1.	Definition	13
8.2.	Why calibrate?	14
8.3.	Calibration mode	14
8.3.1.	Displaying the valid calibration factor - resetting the factory calibration factor (if necessary)	14
8.3.2.	Calibration during simulated operation	16
8.3.3.	Meter calibration during simulated operation	16
8.3.4.	Changing the K FACTOR directly	19
9.	Configuration of the meter	21
10.	Maintenance	21
10.1.	Exchanging batteries	22
10.2.	Cleaning	22
11.	Troubleshooting	23
12.	Repairs/service	23
13.	Disposal	24
14.	Exploded view of the turbine flow meter	24
15.	EC Declaration of Conformity	26



Operating instructions - turbine flow meter

1. Introduction

1.1 Preface

Please carefully read these operating instructions and observe in particular all safety notes!

Our staff will be pleased to provide support if you have any questions about the product.

Yours sincerely, FMT Swiss AG

1.2 Obligations of the personnel

Before they start to work, all persons who are entrusted with work with the turbine flow meter, are obliged:

- to follow all applicable regulations on occupational safety and accident prevention.
- to read and to comply with all safety instructions and warning notes contained in these operating instructions.

Please observe the following instructions in the interest of all concerned:

- Refrain from any unsafe working methods!
- Adhere to all hazard and warning notes contained in this manual!
- In addition to this documentation, keep to all generally accepted safety rules, legal provisions as well as all other binding rules regarding occupational safety, accident prevention and environmental protection!
- Wear appropriate protective clothing in accordance with the work to be done!
- Perform only work for which you have been sufficiently trained and instructed!
- Only genuine spare parts as well as original tools and auxiliaries of the manufacturer are allowed to be used in order to ensure the functional safety and maintain the warranty coverage.

1.3 Symbols in this manual

1.3.1 Structure of the warning notes

The warning notes have the following structure:



SIGNAL WORD

Type and source of the hazard

- Consequences of non-compliance with the notes
- Measures to avoid that risk

Depending on the danger level, different signal words are used

Signal word	Danger level	Consequences of non-compliance
DANGER	Imminent threat of danger	Death or serious bodily injury
WARNING	Possible threat of danger	Death or serious bodily injury
CAUTION	Possibly dangerous situation	Minor bodily injury
ATTENTION	Possibly dangerous situation	Damage to material property



Operating instructions - turbine flow meter



NOTE

Indicates further information or tips which facilitate work.

1.3.2 Hazard symbols

Symbol	Meaning
	General hazard symbol. The warning note marked in this way contains supplementary information on the type of hazard.
	This symbol warns of dangerous electrical voltages.
	This symbol warns of a hazardous explosive atmosphere.

1.3.3 General symbols

Symbol	Meaning
■	A small black square indicates the work you have to perform.
–	The arrow identifies cross-references.
⇒	The arrow identifies cross-references. If cross-references to other chapters are required within the text, the expression is shortened for reasons of clarity. Example: ⇒ Chapter 2 Safety instructions This means: please refer to chapter 2 for the safety instructions.

2. Safety instructions

Various dangers may occur if the turbine flow meter is improperly handled during installation, commissioning and daily operation.



WARNING

Risk of injury and damage to material property because of improper handling!

- Hold the manual at the disposal of the operating staff at the usage site of the unit.
- Country-specific safety measures and accident prevention regulations must be observed.

Operating instructions - turbine flow meter

2.1 Authorized personnel

Only qualified and authorized persons are allowed to operate and to work on the turbine flow meter.

Persons are qualified if they are, due to their training, experience, instruction and knowledge of the relevant standards, able to assess assigned tasks and to identify potentially hazardous situations.

These persons must have been authorized by the person responsible for the safety of the unit and must be able to identify and to avoid potential dangers.

All persons charged with installation, operation, maintenance and repair work, must have read and understood this operation manual.

A copy of this operating manual must be stored permanently and ready at hand at the place of usage of the unit.

2.2 Risks when handling the turbine flow meter



DANGER

- The turbine flow meter is only suited for use with hardly inflammable media.
- The turbine flow meter is not allowed to be used in potentially explosive environments.

Damaged accessories can lead to personal injury and material damage.

- Accessories must be checked for wear, splits or other damage throughout their period of use.
- Damaged accessories must be replaced immediately.
- With reference to the period of use, please note the details in ZH 1/ A45.4.2 or DIN 20066, part 5.3.2

Escaping liquids can cause environmental harm.

Comply with the stipulations of the German Water Resources Act (WHG) and of the Plant Regulations of the German federal states (VawS).

3. Intended use

This turbine flow meter has been designed and built for measuring volumes of various media featuring different viscosities, and for the storage of data so collected.

The turbine flow meter is intended for installation at the end of an output hose, e.g. a hose reeler.

3.1 Design and functional description

The turbine flow meter is a fluid meter with electronic counter & memory and digital display.

The medium flowing through the meter sets a turbine in rotation. The revolutions of the gears are converted into electronic pulses and sent to the electronic counter by a Reed switch. The electronics, finally, uses a certain multiplication factor to convert the pulses into an intelligible volume of liquid having gone through the device, which is then shown on the LCD display.

The multiplication factor has been pre-set at the factory using an average that has turned out to be useful in normal operation. However, it can be easily adapted to specific requirements by the user.

The total volume measured is stored and can be called up by pressing the TOTAL button.

Data collection and analysis are being constantly monitored by the electronics. Errors are reported immediately.

Operating instructions - turbine flow meter

The electronic counter needs a two-phase input signal that's being monitored for phase errors. A self test is being carried out before every RESET.

The user needs only two membrane key switches for operation: RESET and TOTAL (i.e. total volume).

The body of the device is made of aluminium.

DISPLAY LCD

MEASURING CHAMBER

RESET BUTTON

TOTAL BUTTON



The electronic components and LCD display sit at the top of the turbine flow meter, far away from and well insulated against the wet measuring chamber. There is a cover to protect them against the working environment.

3.1.1 Display LCD

The meter's LCD display is equipped with two numeric registers and different types of display modes showing information to the user only when it is actually needed with the operation / function going on at the moment.

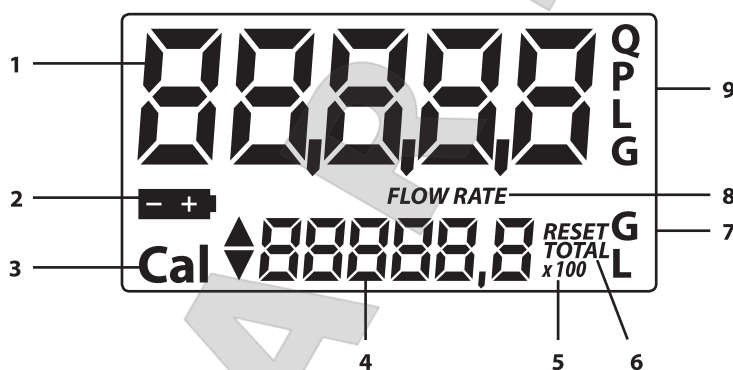

Key:

1. Register of partial volume (5 digits with floating decimal: 0.000+99999) showing the amount of liquid that has been delivered since the RESET button was last pressed
2. Battery charge
3. Display of the calibration mode
4. Register of total volume (6 digits with floating decimal 0.0-999999x10/x100) showing two different kinds of total volumes:
 - 4.1 Non-resettable total volume (TOTAL)
 - 4.2 Resettable total volume (RESET TOTAL)

Operating instructions - turbine flow meter

5. Total volume multiplication factor (x10/x100)
 6. Type of total volume display (TOTAL/RESET TOTAL)
 7. Units for total volume; L=litres; GAL=gallons
 8. Flow-Rate-display
 9. Display of measuring unit for partial volumes:
 QTS=quarters; PTS=pints; L=litres; GAL=gallons;
- The display can be adapted to the direction of flow in 90° steps. To do so, loosen the four screws (fig. 3-1). Now you can mount the display unit turned 90°.

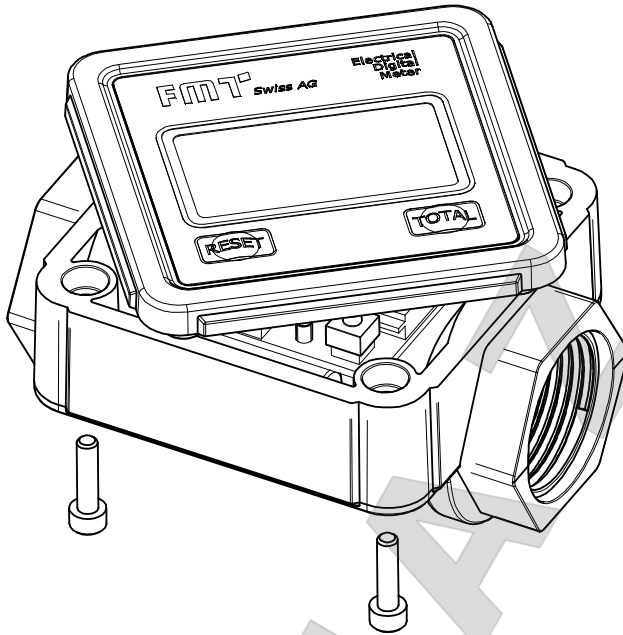

Fig. 3-1: Adjustment of flow direction display unit



NOTE

- O-ring (⇒ **chapter exploded view**) item 10 must be re-mounted correctly.
- Do not pinch or excessively twist the cables item 11 from the battery compartment (⇒ **chapter exploded view**) to the PCB (item 14).

Then re-insert and tighten the screws (item 1).

3.1.2 User controls

There are two push buttons on the meter (RESET and TOTAL), each controlling two main functions (pressed individually) and various auxiliary sub-functions (pressed simultaneously).

Main functions:

- RESET button: Resetting the partial volume register and the (resettable) total volume register RESET TOTAL.
- TOTAL button: Calling up the calibration mode. Pressed together, the two buttons call up the configuration mode where you select the unit of measurement.

Operating instructions - turbine flow meter (GB)

3.1.3 Measuring chamber

The measuring chamber is located in the centre of the meter.

There is a turbine in the measuring chamber, set in rotation by the flow of liquid. Each revolution will generate an electrical pulse that is processed by the microprocessor on the control circuit board.

The microprocessor uses a calibration factor (i.e. a 'weighting' assigned to each pulse) to convert the pulses generated by the gears' revolutions into an intelligible value representing the volume of liquid that has passed through. It is then displayed in the unit pre-set before in the corresponding registers of the LCD display for partial and total volumes, respectively.

All of our turbine flow meters leave the factory with a default calibration factor = 1000 called „FACTORY K FACTOR“. There is a possibility to calibrate the meter in order to adapt that factor to the physical properties of different liquids.

There is always a possibility to return to the manufacturer's default setting.

3.1.4 Battery compartment

The meter is powered by two 1.5 V standard batteries (N1).

The battery compartment is inside the body. To replace the batteries, you must remove the cover.

4. Technical data

Designation		23 295	23 295 870 23 295 871
Measuring system		Turbine	Turbine
Compatible liquids		heating oil, diesel, hydraulic oils	AdBlue®
Accuracy	l/impuls gal/impuls	0,017 / 0.0045	0,017 / 0.0045
Flow rate range	l/min gpm	15-100 4-26.4	15-100 4-26.4
Operating pressure	bar / psi	3,5 / 50	15 / 215
Burst pressure	bar / psi	28 / 400	60 / 870
Operating temperature	°C °F	-10 / +50 +14 / +122	-10 / +50 +14 / +122
Storage humidity	R.F.	95 %	95%
Max. operating temperature.	°C °F	60 140	40 104
Flow rate loss at max. flow (with diesel oil)	bar / psi	0,2 / 2.9	0,2 / 2.9
Viscosity range	cSt	2 - 2000	2 - 2000
Accuracy (within flow rate range)		±0,5 %	±0,5 %
Repeatability		0,2 %	0,2 %
Weight	kg / lbs	0,48 / 1.06	0,96 / 2.12
Threads at inlet and outlet		G 1" fem	G 1" fem
Power supply (batteries)	V	2 x 1,5	2 x 1,5
Lifetime of batteries	h	14.000 - 30.000	14.000 - 30.000

Tab. 4-1: Technical data

Operating instructions - turbine flow meter

5. Montage

The turbine flow meter comes pre-assembled and ready to go.

According to the version, accessories may be or must be mounted.



NOTE

- Ensure cleanliness during installation and an exact connection of the accessories with the pump housing.

6. Installation

The inlet and outlet of the turbine flow meter are aligned in a straight axis and equipped with 1" threads. The meter may be installed in any given position, as a fixed unit in a pipeline and/or as a mobile unit on a spigot.

The turbine flow meter does not have a pre-defined flow direction. Both ends may alternatively serve as inlet or outlet, as needed. However, it is absolutely important that the side that is used as inlet (where the pipeline arrives) is equipped with a filter with suitable performance characteristics. Solid particles getting into the measuring chamber might clog up the turbine.

7. Routine operation

The turbine flow meter comes pre-assembled and ready to go.

Even after periods of prolonged storage, it will be ready for operation without any lengthy preparations.

The only action that may be necessary from time to time during normal operation is to reset the registers of partial and/or resettable total volumes.

To accomplish that, call up the two displays for normal operation. The first normal operation display contains the partial volume and resettable total volume (RESET TOTAL). The other display shows the partial volume and the non-resettable (absolute) TOTAL volume. The LCD automatically switches between resettable and absolute total. This has been set at the factory and cannot be influenced by the user.

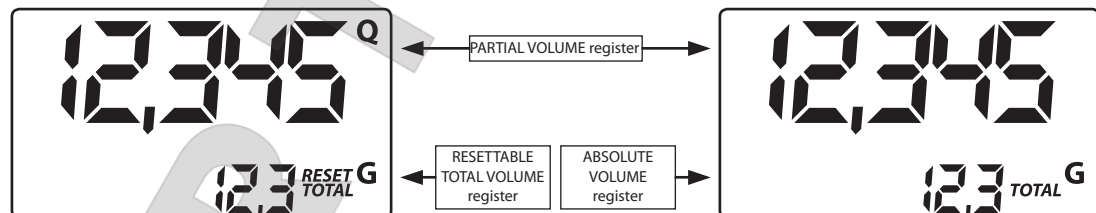

The register of the absolute total (TOTAL) cannot be reset by the user. It will continue counting during the entire lifetime of the meter. The resettable and non-resettable registers of total volumes (RESET TOTAL and TOTAL) share the same 'window' and the same digits of the LCD display. For that reason, the two numbers cannot be viewed at the same time.

The turbine flow meter has been programmed so that the one or the other total is visible at certain moments / in certain modes during operation (never both at a time):

- The absolute total volume (TOTAL) is visible in standby mode.
- The resettable total (RESET TOTAL) is visible at the following times / in the following modes:
 - For a short moment (several seconds) after resetting the (resettable) partial volume.
 - During the output of liquid.

A few seconds after output of the liquid this short time span expires and the meter switches to standby mode. The display of the bottom register shows the absolute total volume.

Operating instructions - turbine flow meter



NOTE

For the display of total volumes, there are 6 digits available, plus two icons x10/x100.

The increments are activated in the following sequence:

0,0 ---> 99999,9 ---> 999999 ---> 100000 x10 ---> 999999 x10 --->

100000 x100 ---> 999999 x100.

7.1 Output of liquid during standard operation (Normal Mode)

During standard output of liquid, the meter will count and at the same time display the volume having gone through the device so far, and the resettable total (RESET TOTAL).

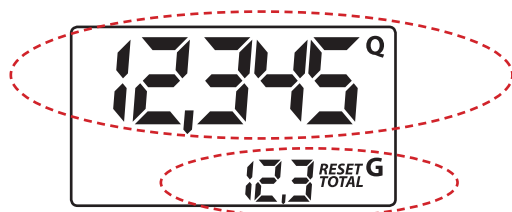

Accidental pressing of the RESET or TOTAL button does not have any effect in this state.

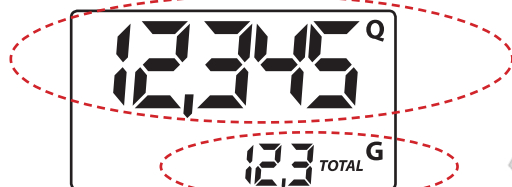

A few seconds after you're finished, the display of the lower register will change from **resettable total** to **absolute total**: The word **RESET** above the word **TOTAL** will disappear, and the value of the **resettable total** will be replaced by the **absolute total**.

We call this state (or mode) „standby“. It will persist as long as the user does not carry out any more actions on the meter.

7.1.1 Resetting partial volumes

For resetting the partial volume register: Press the RESET button while the meter is in standby, i.e. when you see the word TOTAL in the display.

When you press RESET, the display will first switch on all the segments, one after the other, and then switch them all off again.

When the reset is complete, the display will first show the partial volume having been reset and then RESET TOTAL.

After a couple of seconds, RESET TOTAL will be replaced by the NON-resettable total amount TOTAL.

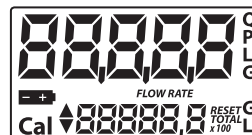

Operating instructions - TURBINE FLOW METER

7.1.2 Resetting the resettable total volume RESET TOTAL

You can reset the resettable total only if you have reset the register of the partial volumes before. To reset the resettable total: press RESET for several seconds. The display will show the words RESET TOTAL (see fig.):



You must carry out the following steps (in this order):

1. Wait until the display is back to default standby mode (i.e. showing only TOTAL).
2. Press RESET shortly.
3. The meter will now start resetting the partial volume register.
4. While the display shows TOTAL RESET, press RESET again for at least one second.
5. The display will show all the segments again. Only then follows the phase where all segments are switched off. Finally, there will be a display showing the total that has been reset (RESET TOTAL).

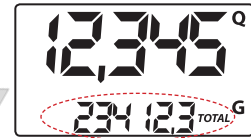

7.2 Output of liquid with display of current flow rate (Flow Rate Mode)

It is possible to output a liquid and have the following displays available:

- Partial volumes having been output
- Current flow rate (Flow Rate) in [unit of partial volume per min.], as shown below.

This is how you get into this mode:

- Wait until the meter is in default standby mode (i.e. the display shows only the total volume).
- Press TOTAL shortly.
- Start output operation.

The display of the current flow rate will be updated every 0.7 secs. For that reason the display may ,flutter' somewhat with low flow rates. However, the higher the flow rate, the more stable the display will be.



NOTE

The current flow rate will be shown in the unit set for the partial volume register. That means if partial and total volume have been set to different units (as shown in the example below) you must bear in mind that the flow rate shown is in the unit set for partial volumes. In the example shown, the flow rate is in QTS./min.

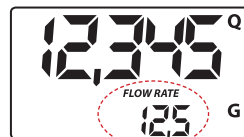

The word GAL next to the flow rate refers to the register of the (resettable and NON-resettable) total volumes which will be displayed again as soon as you leave the ,current flow rate' display mode.

Operating instructions - turbine flow meter

In order to go back to the default standby mode, press the TOTAL button again.

Accidental pressing of the RESET or TOTAL button does not have any effect in this state.



NOTE

RESET TOTAL and absolute total (TOTAL) are not shown in this mode. However, the values nevertheless go up. You can check after you're finished. Wait for the default standby mode and press TOTAL shortly.

7.2.1 Resetting partial volumes

In order to reset the partial volume register, you must first complete the output of liquid. Wait until the display shows a flow rate of 0.0 (see fig.) and then press RESET shortly.

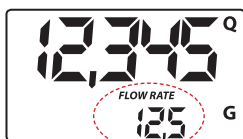

The effect is different from what you would have if you press Reset in default standby mode. There is no phase where all the segments are first switched on and then off again. Instead, the register will display the reset partial volume immediately.

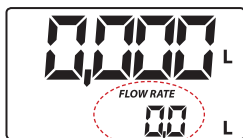

8. Calibration

8.1 Definition

Calibration factor or „K FACTOR“:

This is the multiplication factor the system ascribes to the electronic pulses it receives in order to convert them into a plain unit of measurement.

- **FACTORY K FACTOR:** Calibration (default) factor pre-set at the factory.
Factory K Factor = 1000.

You can always return to the original Factory K Factor even after you have changed the value. The procedure is simple.

- **USER K FACTOR:** This is the calibration factor the user has set to adapt the meter to specific requirements (i.e. the user has carried out a calibration procedure).

Operating instructions - turbine flow meter

8.2 Why calibrate?

The turbine flow meter comes to you with a calibration factor pre-set at the factory that will guarantee the most precise measurements under most operating conditions.

If calibration is necessary, it should be conducted under the operating conditions in which the meter is used, such as in the following extreme conditions:

- liquids having a viscosity close to the admissible limits (e.g. antifreeze with low viscosity, high-viscosity oils for gearboxes)
- extreme flow rates (i.e. close to upper or lower limits)

8.3 Calibration mode

The turbine flow meter has a fast and precise electronic calibration mode where you simply change the so-called calibration factor (K FACTOR).

There are two calibration procedures you may choose from:

- Simulated operation + calibration (requiring actual output of liquid to be carried out)
- Direct calibration (simply changing the calibration factor)

You may want to call up the calibration procedure for the following reasons (press the TOTAL button for several seconds):

- To display the valid calibration factor
- To reset the calibration factor pre-set at the factory (FACTORY K FACTOR) after calibration by the user
- To change the calibration factor using one of the two available calibration procedures

During calibration, the registers on the LCD display - that normally show partial and total volumes of liquid output - will take on new meanings.

During calibration, the meter cannot carry out normal output operation.

During calibration, the count of the absolute total volume of liquid having been output (non-resettable total) will not increase.



NOTE

The turbine flow meter is equipped with a non-volatile memory so that saved calibration data and the total output amount will be stored for prolonged periods of time - even without power supply. That means you don't have to re-calibrate after you have exchanged the batteries.

8.3.1 Displaying the valid calibration factor - resetting the factory calibration factor (if necessary)

Go to default standby mode. Press the TOTAL button. The display shows the valid calibration factor.

Two situations are possible:

- a) User never changed the calibration factor and/or user restored the factory calibration factor after changing it: the display will show the following:

The word FACT (short for FACTORY) indicates that the valid calibration factor is the factor pre-set at the factory.



- b) If calibrations have been made by the user, the calibration value currently used is indicated (in our example 0,998).

The word USER indicates that the calibration factor currently used was entered by the user.

Operating instructions - turbine flow meter







The flow chart below shows the schematics of the display modes the LCD display may go through. In this mode, the user may press RESET and thus change from the USER to the FACTORY FACTOR. In order to confirm your choice, shortly press TOTAL while the display shows either USER or FACT. After re-start, the meter will use the new calibration factor you just confirmed.



NOTE

When you confirm restoration of the Factory K Factor, the old user factor will be deleted from memory.

Key

-  Reset long
-  Reset short
-  Total long
-  Total short
-  Time OL 1

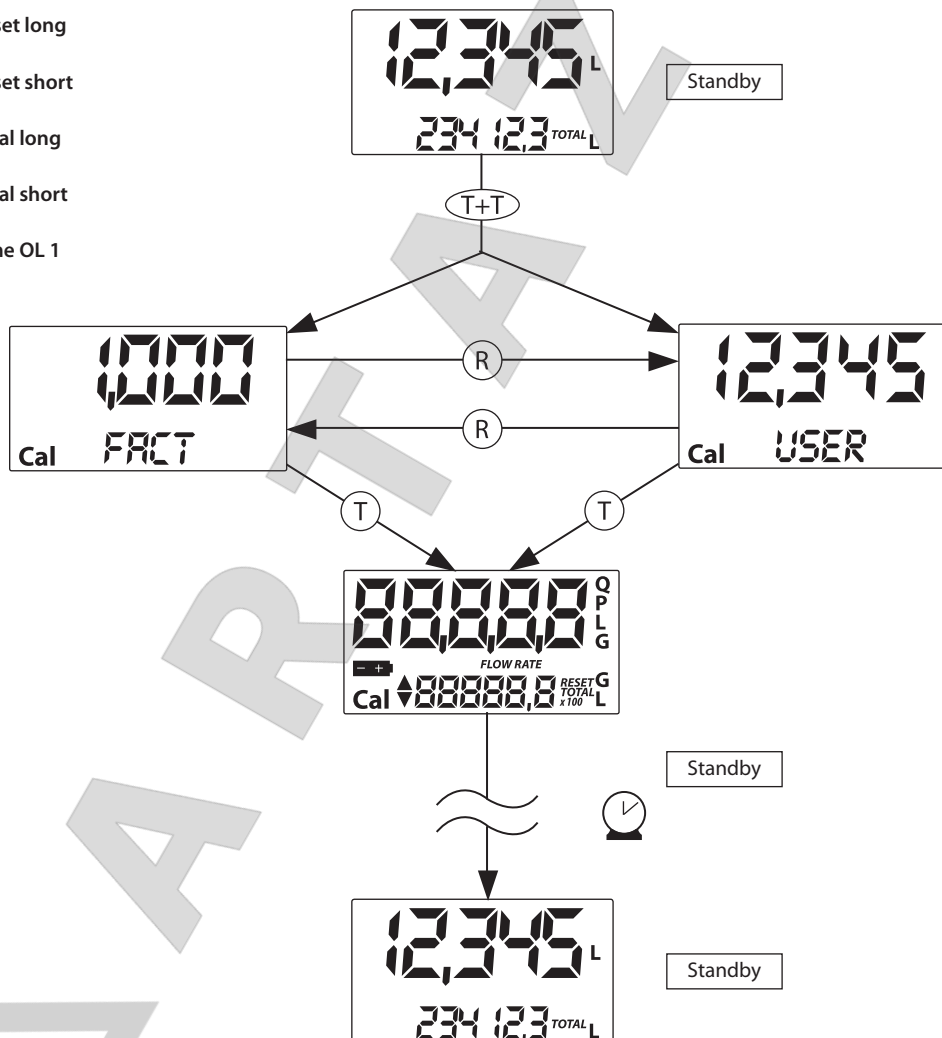

Operating instructions - turbine flow meter

8.3.2 Calibration during simulated operation

This procedure is basically a simulated output of liquid into a calibration vessel under actual operating conditions (flow, rate, viscosity etc.). The procedure must be carried out with utmost care..

Absolutely bear in mind the following points in order to guarantee proper calibration:

- Have your equipment properly vented before calibration.
- Use a calibrated vessel holding at least 5 litres with a precise full mark.
- For calibration, tap a certain amount of test liquid with a constant flow rate, exactly as you would do in normal operation. Continue until the vessel is full.
- Do not decrease the flow rate when you approach the full mark. Instead, turn the spigot on and off and fill the vessel in small batches, but make sure the flow rate remains unchanged..
- When you're finished be sure to wait a few minutes and let air bubbles escape that may still be in the calibration vessel. Otherwise there is a danger you get a wrong value because the level in the vessel may still go down.
- Be sure to carry out the following procedure correctly.

8.3.3 Meter calibration during simulated operation

Operation

- 1 NONE
Meter is in default standby mode, not counting.
- 2 PRESS TOTAL SEVERAL SECS
Meter switches to calibration mode, displaying TOTAL. Display no longer shows total volume, but instead the valid calibration factor. FACT and USER indicate whether valid calibration factor is FACTORY K FACTOR or USER K FACTOR.
- 3 PRESS RESET SEVERAL SECS
Meter shows TOTAL display and the resettable total register displays zeroes. Meter is now ready for simulated operation calibration.

Display-Konfiguration



Operating instructions - turbine flow meter

4 FILL LIQUID INTO CAL VESSEL

Start simulated operation, but do not press any buttons yet.

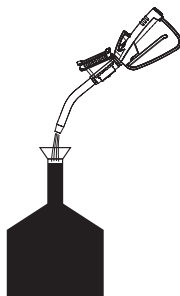

Simulated operation may be interrupted and continued as necessary. Continue filling the vessel until full mark is reached. It is not necessary to top out at any specific value.

Set value

Actual value

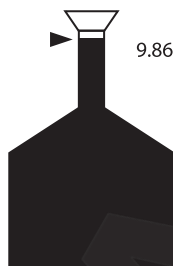

5 PRESS RESET SHORTLY

This is how the meter, knows' that sim op for calibration is complete. Make sure cal vessel has really been filled up to full mark before you do this.

For calibration you must correct the count indicated by the partial volume register (ex.: 9,800), entering the actual value, i.e. the volume of the cal vessel. An arrow at the bottom left of the display (pointing up or down) indicates the direction in which USER K FACTOR is changed.



6 PRESS RESET SHORTLY

Direction of arrow flips. This may be repeated as often as necessary.



Operating instructions - Turbine Flow Meter

7 PRESS TOTAL SHORTLY / SEVERAL SECS

Value indicated will change as indicated by arrow:

- One increment per each time TOTAL is pressed.
- Continuous if the TOTAL button is held down, the first 5 increments slow, then fast.
- If you overshoot, go back to point 6 and repeat (6).



8 PRESS RESET SEVERAL SECS

This is how the meter 'knows' that calibration is now complete.

Before you press the button, be absolutely sure the display shows the correct value (volume of vessel).



Set value

Actual value

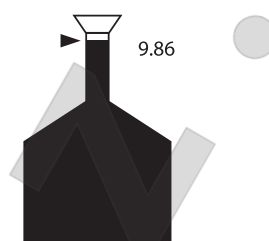

The meter will now calculate the new USER K FACTOR: This may take a couple of secs. depending on the complexity of the correction. The arrow will disappear during this phase, but the word TOTAL will remain unchanged.

If you carry out this action right after point 5 the new USER K FACTOR will be equal to the FACTORY K FACTOR. It will be ignored, therefore.

9 NO OPERATION

After completion of the calculation the new USER K FACTOR will be displayed a few seconds. Next, the meter will re-start. Finally, the meter will be back in default standby mode.

Please note: From now on, the new value set will be used as the new valid K Factor and will remain even after replacement of batteries!

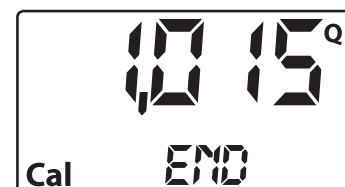

10 NO OPERATION

The meter stores the new K Factor for operation and is now ready for serious operation using the newly set USER K FACTOR.



Operating instructions - turbine flow meter (GB)

8.3.4 Changing the K FACTOR directly



This procedure is helpful for the correction of a mean error that may occur as a result of many output operations. In the event you observe a mean percentage error during normal meter operation you may carry out a correction by changing the valid User K Factor by that percentage. In order to calculate the correction of the USER K FACTOR, proceed as follows:

$$\text{New calibration factor} = \text{old calibration factor} \times \frac{100-E\%}{100}$$

Example:

Observed mean percentage error E %	-0,9%
Current K Factor	1.000
New USER K FACTOR	1.000 x {[100-(-0,9)]÷100}=
	1.000 x [(100+0,9)÷100]=
	1.009

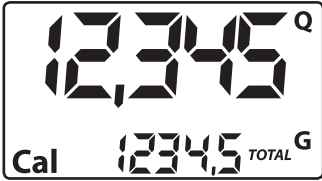
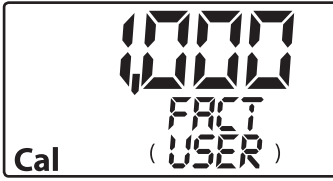
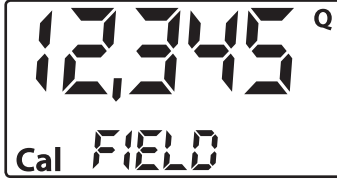
If the meter displays less than the actual amount of liquid output (negative error), the new K Factor must be greater than the old one (see example). The opposite is true if the value indicated is greater than the actual amount (positive error).

Operation	Display-Konfiguration
1 NONE Meter is in default standby mode, not counting.	
2 PRESS TOTAL SEVERAL SECS Meter changes to calibration mode displaying the valid K Factor instead of the partial volume. FACT or USER indicates whether valid calibration factor is Factory K Factor or User K Factor.	
3 PRESS RESET SEVERAL SECS Meter shows TOTAL display and the resettable total register displays zeroes. Meter is now ready for simulated operation calibration.	
4 PRESS RESET SEVERAL SECS Changing valid K Factor directly: The word DIRECT is displayed, together with the calibration factor currently in use. An arrow at the bottom left of the display (pointing up or down) indicates the direction in which the displayed value is changed. Increase or decrease when actions 5 or 6 are carried out.	



Operating instructions - TURBINE FLOW METER

5 PRESS RESET SHORTLY

Direction of arrow flips. This may be repeated as often as necessary in order to set the correct direction.



6 PRESS RESET SHORTLY / SEVERAL SECS

Value indicated will change as indicated by arrow.

- One increment per each time TOTAL is pressed.
- Continuously if TOTAL is held down. Display will,roll' more quickly if button is held permanently.

If you overshoot, go back to point 5 and repeat.



7 PRESS RESET SEVERAL SECS

This is how the meter, 'knows' that calibration is now complete.

Before you press this button, be absolutely sure the value indicated is the value you wanted to set.



8 NONE OPERATION

After the following calculation the new USER K FACTOR will be displayed a few secs. Next, the meter will re-start. Finally, the meter will be back in default standby mode.

Please note: From now on, the new value set will be used as the new valid K Factor and will remain even after replacement of batteries.



9 NONE OPERATION

The meter stores the new K Factor for operation and is now ready for serious operation using the newly set USER K FACTOR.



Operating instructions - turbine flow meter (GB)

9. Configuration of the meter

The turbine flow meter has a menu to assist users in the selection of the main unit of measure: quarters (QTS), pints (PTS), litres (L), gallons (GAL).

Combining partial-volume and total-volume units is possible as shown in the following table:

Combination no.	Unit Register of partial amounts	Unit Register of total amounts
1	litres (L)	litres (L)
2	gallons (GAL)	gallons (GAL)
3	quarters (QTS)	gallons (GAL)
4	pints (PTS)	gallons (GAL)

This is how you select any of the combinations proposed:

Wait until the meter is in default standby mode. Simultaneously press TOTAL and RESET until the display shows the word „UNIT“ displaying the valid unit being used at present (in our example: litres/ litres).

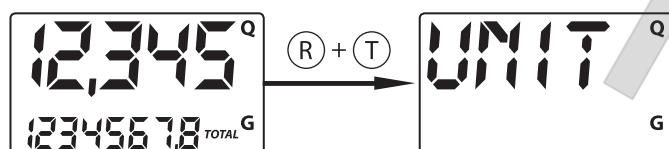

Every time you (shortly) press RESET, one of the other combinations of units will be displayed one after the other (see figs.):

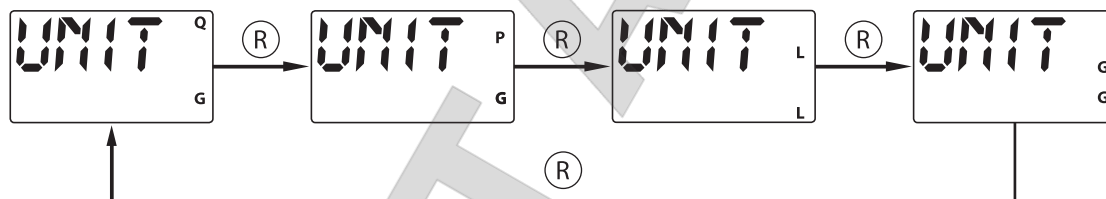

Press TOTAL for several seconds to store the new combination. The meter will re- start and is then ready for operation using the newly selected combination of units.



NOTE

The registers of the resettable and absolute total amounts are automatically set to the new measuring units.

When the measuring unit is modified, a new calibration is NOT required.

10. Maintenance

This turbine flow meter has been designed for minimum maintenance requirements. What remains to be done from time to time:

- Exchange the batteries when discharged.
- Clean the measuring chamber. This may be necessary from time to time depending on the specific liquid(s) being measured and/or when foreign matter gets into the chamber (inlet filter not sufficient).

Operating instructions - turbine flow meter

10.1 Exchanging batteries

The meter is supplied complete with two 1.5 V alkaline batteries (1N).

The meter has a two-step low battery indicator:

- 1) As soon as the batteries dip below the first charge level the battery icon in the display will light up.

The meter will continue to operate correctly, but the user is informed that the batteries should be exchanged as soon as possible.



- 2) If the batteries are not exchanged, the battery will sooner or later reach the second alarm level. Normal operation is no longer possible. At this state, the battery icon will flash, being the only thing that is still visible in the display.

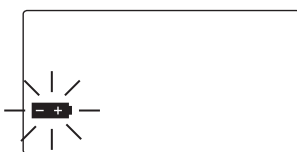

NOTE

Do not throw batteries in the dustbin. Be sure to know and respect local regulations concerning proper disposal.

Proceed as follows (items correspond to spare parts list):

- Press RESET in order to update total volume.
- Unscrew the battery cover (pos. 8).
- Remove the old batteries.
- Insert new batteries. Observe + and - icons on batteries and cap (pos. 1).
- Replace battery cap properly and screw down tightly. Make sure the seal (pos. 7) and spring (pos. 9) are in their correct positions.
- The meter will go on automatically and revert to default standby mode. Routine operation may now be continued.

The values of the resettable and non-resettable totals and partial volume will be the same as before.

Neither will the calibration (K) factor change in the case of power failures and/or exchange of batteries. It is not necessary to re-calibrate the meter after exchange of batteries.

10.2 Cleaning

The measuring chamber of the turbine flow meter can be cleaned only after disconnecting the meter from the pipeline or spigot. The inlet and outlet must be fully accessible.



NOTE

Always make sure that ALL the liquid has been removed from the device before you start cleaning it.

The turbine flow meter has no filter that needs to be cleaned. Therefore, it is only possible to determine at the inlet and outlet whether large particles have gotten caught in the meter. If there are any foreign objects in the meter, they can be removed with a pointed object, such as a small screwdriver, or needle nose pliers.

Operating instructions - turbine flow meter



CAUTION

Never blow compressed air into the meter, since the resulting high speed of rotation can cause the magnets to become loose.

After removing larger objects, a suitable liquid can be used to rinse out smaller foreign particles. It is best to use diesel fuel or heating oil for this.



NOTE

Be careful not to damage the body of the device and the plastic parts.

11. Troubleshooting

Malfunction	Cause	Solution
LCD display: No display	▶ Loose battery contacts	▶ Check batteries for good contact
Accuracy of measurements is insufficient	▶ K FACTOR wrong ▶ Meter operates below admissible min. flow rate	▶ Check K FACTOR, ⇒ see chapter 8.3 ▶ Increase flow rate to acceptable level
Reduced flow rate, or no flow at all	▶ Turbine blocked	▶ Clean measuring chamber
Display flashing „Err 1“	▶ Data stored in electronic memory are damaged	▶ Sorry, irreparable
Short display of „Err 2“	▶ Limited error reading data (usually when exchanging batteries)	▶ Control circuit board automatically switches on and off to restore proper operation

12. Repairs/service

This turbine flow meter has been designed and built in compliance with the highest quality standards. If a problem should occur despite all quality measures taken, please get in touch with our service contact partners:

FMT Swiss AG

Tel +49 9462 17-216

Fax +49 9462 1063

service@fmtag.ch

Operating instructions - turbine flow meter

13. Disposal

The operating company is responsible for the proper disposal of the turbine flow meter.

Only qualified personnel is authorized to disassemble and dispose of the turbine flow meter.

Dispose of the turbine meter properly and free of any liquid residues or dispose of it by a specialist company. Pay attention to all national legislation in force in your country.

The battery must be disposed of separately from the turbine meter as a special waste.

14. Exploded view

Pos.	Quantity	Designation	Item number
1	4	Screw	82 408
2	2	Permanent magnet	03 003
3	1	Turbine	82 406
4	1	Cylindrical pin	82 405
5	2	Bearing bush	82 404
6	2	Sphere	87 639
7	2	Turbine bearing	82 403
8	2	Snap ring	82 402
9	1	Housing	82 401
10	1	O-ring	82 400
11	2	Battery box	82 356
12	2	Battery	88 431
13	4	Screw	85 572
14	1	Board	82 399
15	1	Display foil, complete	82 397
16	1	Cover	82 396

Tab.: 13-1 List of the individual components of fig. 13-1

Operating instructions - turbine flow meter GB

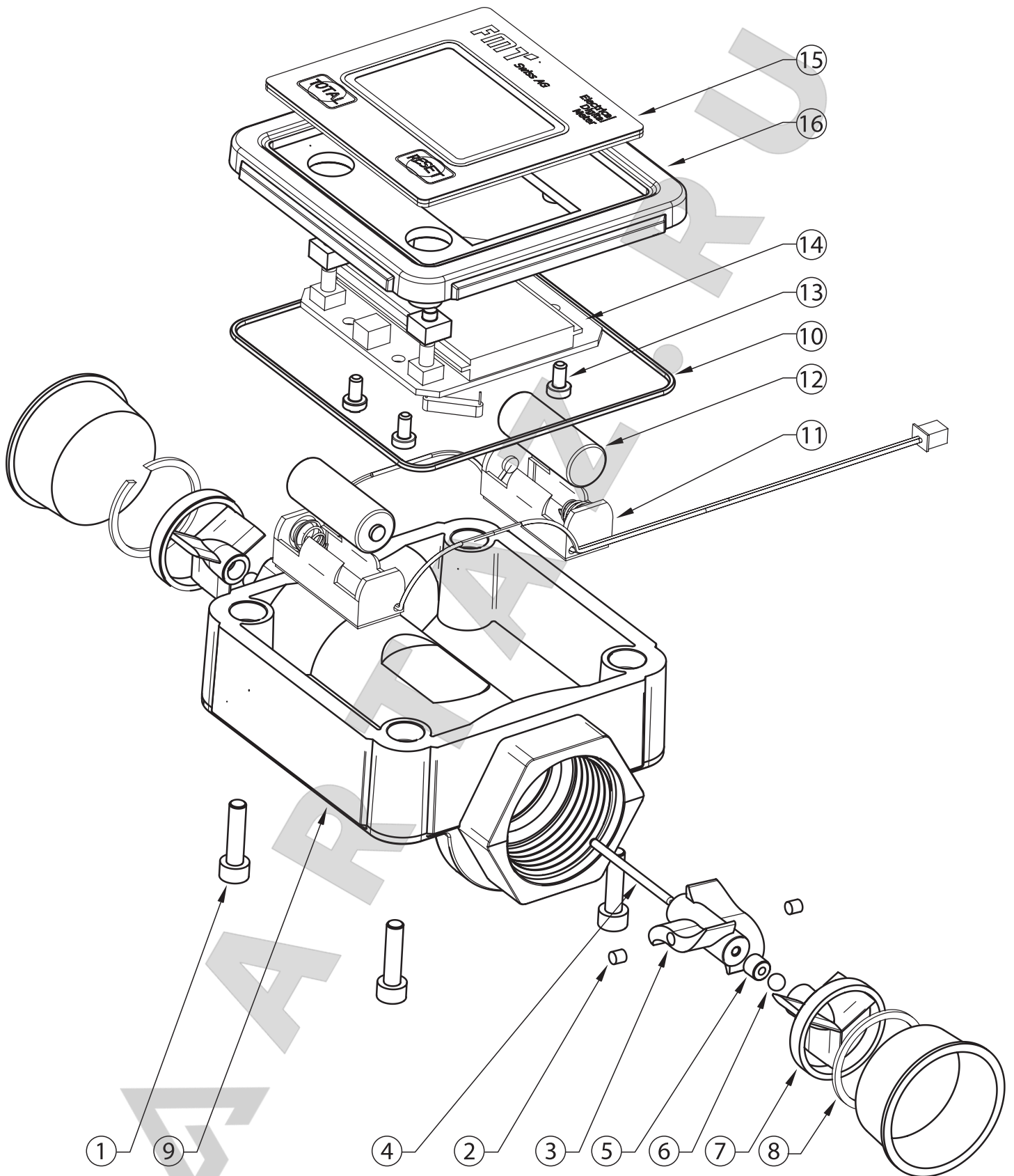

Fig. 13-1 Exploded view of the turbine flow meter

Operating instructions - turbine flow meter

15. EC Declaration of Conformity



Manufacturer:

FMT Swiss AG

Fluid Management Technologies Swiss AG

Gewerbestraße 6

6330 Cham / Schweiz

Declares under his sole responsibility that the machine:

Model type	Turbine flow meter 23 295 23 295 870; 23 295 871
Function	Fluid meter with electronic counter & memory and digital display.
Complies with all relevant provisions of the following Directive:	
EC Directives	2014/30/EU EMC Directive
Applicable standards	EN 61000-6-1:2007 EN 61000-6-3:2007/A1:2011 EN 55014-1:2006/+ A1:2009 +A2:2011 EN 55014-2:2015

Authorized representative for the compilation of the technical documentation:

Name: Maria Gross
 Address: Fluid Management Technologies Swiss AG
 Gewerbestraße 6
 6330 Cham / Schweiz
 Phone: +49 09462/ 17 -218

FMT Swiss AG
 Cham, 28.10.2016



Dipl.-Ing. Rudolf Schlenker
 (Managing Director)

Operating instructions - turbine flow meter

ARTAZ.RU

FMT Swiss AG

Fluid Management Technologies Swiss AG
Gewerbstraße 6
6330 Cham / Schweiz
Tel. +41 41 712 05 37
Fax +41 41 720 26 21
info@fmtag.com
www.fmtag.com

ARTAZ.RU

FMT  **Swiss AG**